

3C行业加工解决方案

Manufacturing Solutions for 3C Industry



+ 华东大区
Eastern China Region

上海市青浦区华强街路三友星墅 203 弄272号 302 室
Add: Room 302, No. 272, Lane 203, Sanyou Xingshu
Huaqiang Street Road, Qingpu District, Shanghai
Tel: +86-0592-3706375

+ 华南大区
Southern China Region

广东省东莞市长安镇德政中路信义怡翠豪园9栋1单元902
Add: 902, Unit 1, Building 9, Xinyi Yicui Haoyuan
Dezheng Middle Road, Chang'an Town
Dongguan City, Guangdong Province
Tel: +86-0592-7310125

+ 西部大区
West Region

四川省成都市龙泉驿区成都航空职业技术学院
Add: Chengdu Aviation Vocational Technology College
Longquanyi District, Chengdu City, Sichuan Province
Tel: +86-0592-7301561

+ 华北大区
Northern China Region

天津市河东区海河东路与八经路交口以东八经路81号
中海钻石湾信和苑 11号楼11门4204室
Add: Room 4204, Gate 1, Building 11, xinheyuan, Diamond Bay
Hedong District, Tianjin, China
Tel: +86-0529-7306375

+ 东北大区
Northeast Region

辽宁省沈阳市铁西区建设东路158号华润铁西中心写字楼2109
Add: No.2109(china Resources Tiexi Center)No.158 Jianshe East Road
Tiexi District Shenyang City Liaoning Province
Tel: +86-0592-7301126

+ 华中大区
Central China Region

武汉经济技术开发区28R地块金色港湾4期26栋2号
Add: No. 2, Building 26, Golden Harbor Phase 4, Block 28R
Wuhan Economic and Technological Development Zone
Tel: +86-0592-7310203

厦门金鹭特种合金有限公司
XIAMEN GOLDEN EGRET SPECIAL ALLOY CO.,LTD.

地址: 中国厦门市湖里区兴隆路69号
Add: No.69 Xinglong Road Huli District Xiamen CHINA
工厂地址: 中国厦门同安工业集中区集成路1601-1629号
Factory Add: No.1601-1629 Jicheng Road Industrial
Concentration Area Tongan Xiamen CHINA
Tel: +86-592-7107392 Fax: +86-592-7107322
PC: 361006 Email: gesac@cxctc.com

www.gesac.com.cn

400-998-6858



GE202303h



厦门金鹭特种合金有限公司,成立于 1989 年,是一家中外合资的国家高新技术企业,隶属于中国六大稀土集团之一的厦门钨业股份有限公司。公司致力于高品质钨粉末材料、硬质合金、精密切削工具等钨系列产品的研发、生产,以及行业专业解决方案的提供,是世界知名的钨粉末、硬质合金及切削工具供应商。

凭借完整钨产业链的产品集成技术研发,以及务实、创新的管理理念,厦门金鹭始终保持着强劲的发展势头,为全球用户提供最高性价比的产品和服务,为现代工业领域解决高硬度、耐高温、耐磨损问题,提供了优良的产品和完善的解决方案,客户遍布全球四十多个工业发达国家和地区,享誉海内外。

公司拥有国内 4 个生产基地和 1 个国家级企业研发中心,海外 3 个销售公司和 1 个海外生产基地,独立承担并完成多项“国家科技支撑计划项目”,“国家科技重大专项”,“国家火炬计划项目”,“国家重点新产品”开发项目及省市重点研究课题,被评为“战略性新兴产业骨干企业”、“创新型企业”、“先进科技企业”。

Xiamen Golden Egret Special Alloy Co., Ltd. (GESAC), founded in 1989, is a Sino-foreign joint venture with national high-tech, affiliated with XTC, which is one of six major rare earth groups in China. GESAC is committed to research & development, production and professional solutions providing of high-quality tungsten powder materials, cemented carbide, precision cutting tools and other tungsten products. Up to now, GESAC has become world-famous manufacturer and supplier of tungsten powder, cemented carbide and precision cutting tools products.

With the Integrated Product Development of complete tungsten industry chain, as well as a pragmatic and innovative management concept, GESAC has always maintained a strong momentum of development, providing the cost effective tungsten powder products and services for global users, offering the excellent products and perfect solutions for solving high hardness, high temperature resistance and wear resistance topics. Our brand "Golden Egret" has become one of the leading brand in the market, enjoying famous reputation in more than 40 countries and regions.

GESAC owns four production headquarters and one national level research center domestically, and three sales branches and one production base overseas. We undertook and completed several development programs independently, including the “National Science and Technology Support Programs”, the “National Torch Program Projects”, and the “National Key Projects” and so on. GESAC was awarded as “Key Enterprise for Strategic Emerging Industry”, “Innovative Enterprise” and “Enterprise with Advanced Technology”.

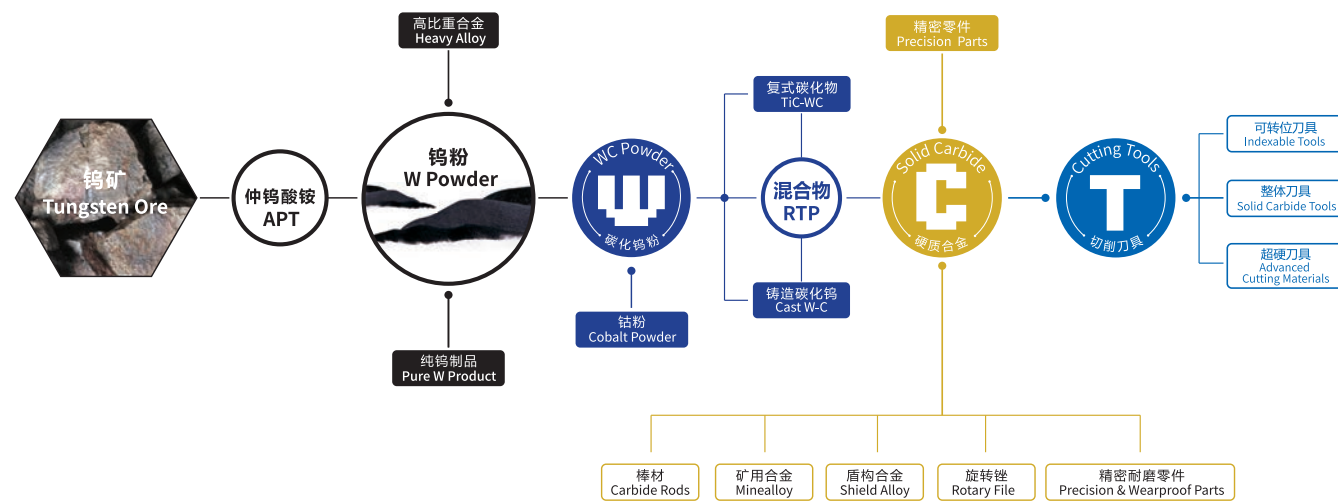

加工解决方案 Manufacturing Solutions

不锈钢手机中框 Mobile Phone Stainless Steel Frame	02
铝合金手机中框 Aluminum Alloy Mobile Phone Frames	04
铝合金笔电上下盖 Aluminum Alloy Laptop Top & Bottom Covers	06
3C小零件 3C Small Parts	08
陶瓷盖板 Ceramic Casings	10





中框轮廓粗加工 Frame Profile Rough Machining

- 轮廓刀片及刀体
Profiling Insert and Holder
提高加工效率,降低单件刀具成本
Improving processing efficiency by reducing tool/piece cost

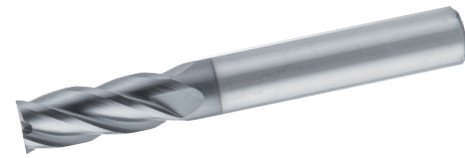

高效面铣粗加工 High Efficiency Rough Face Milling

- 高效面铣立铣刀
High Efficiency Face Milling
加工效率提升50%以上
Processing efficiency increased by 50%

中框轮廓精加工 Frame Profile Fine Machining

- 整硬外观立铣刀
Exterior Profile Solid Carbide Endmill
加工表面无横纹、振纹等缺陷
Post processing surface has no defect horizontal grain or vibrate grain etc.

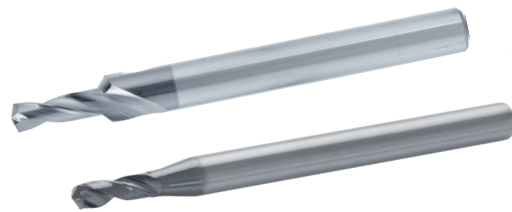
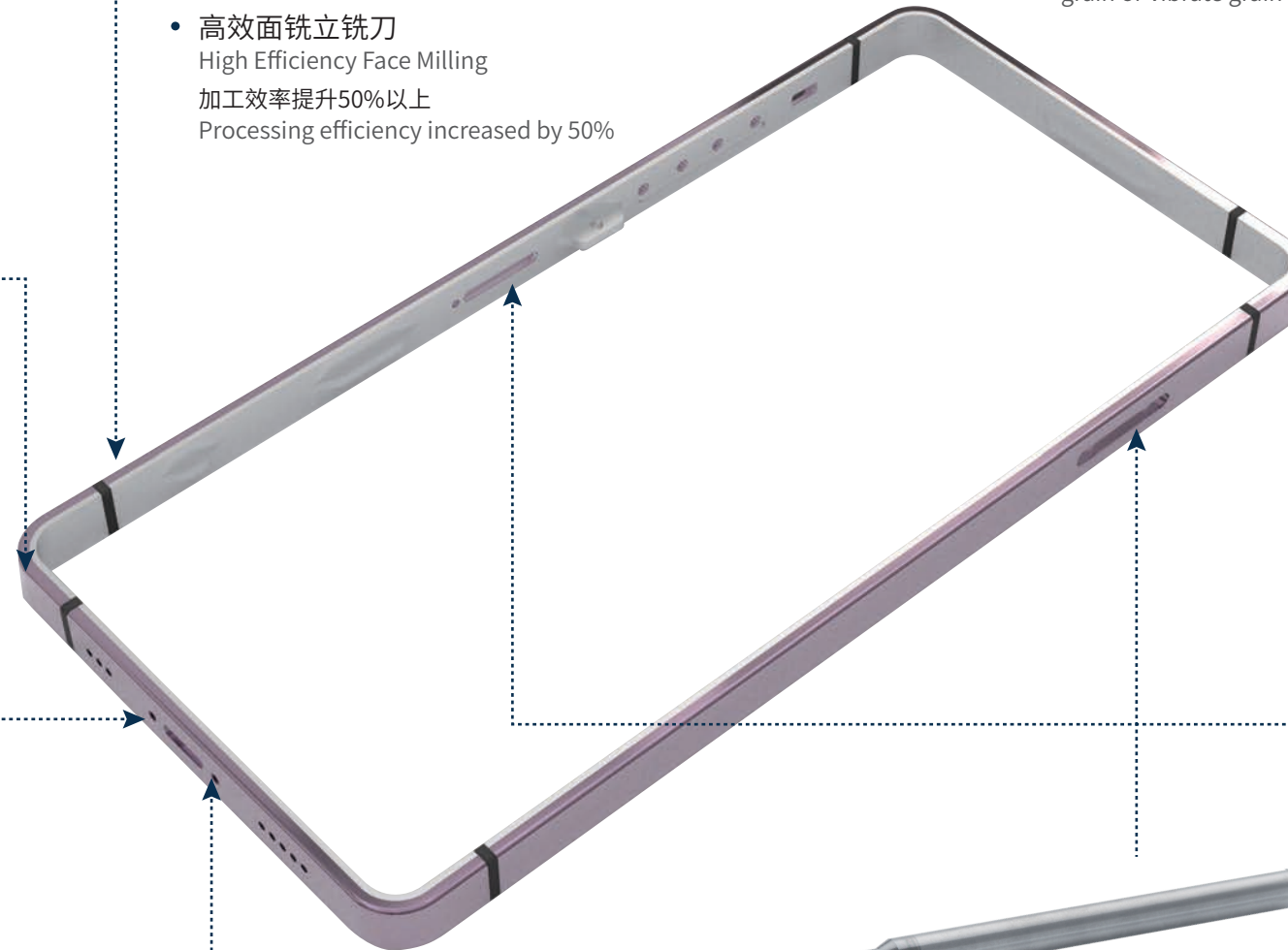
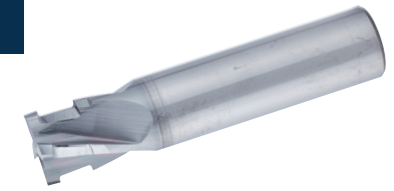

微孔加工 Micro-hole Making

- 小规格钻头/阶梯钻
Small Drill/Step Drill
断屑能力强,刀具寿命高
Great chip breaking ability with long tool life



螺纹加工 Thread Machining

- 挤压丝锥
Tap
有效解决因丝锥磨损或断刀造成废品问题
Effectively solving discard cutter problem caused by abrasion or snap



深/窄槽加工 Deep/Narrow Slot Machining

- T型刀/燕尾刀
T-Shape Cutter/ Dovetail Cutter
解决深沟T槽易断刀问题
For solving the T-shape cutter easy to snap problem

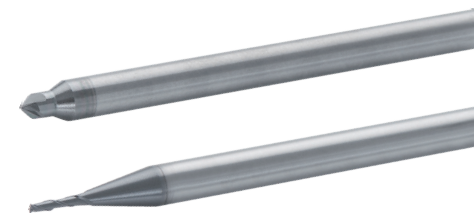

侧孔加工 Side Hole Making

- 不锈钢立铣刀/倒角刀
Stainless Steel Endmill/Chamfer Cutter
加工表面无毛刺,刀具寿命高
Post processing surface has no bur with long tool life

高效粗加工 High Efficiency Rough Machining

- SA100高效立铣刀
SA100 High Efficiency Endmill
加工效率提升50%
Increasing processing efficiency by 50%

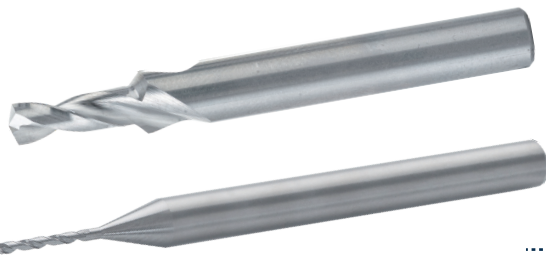

微孔加工 Micro-hole Making

- 小规格钻头/阶梯钻
Small Drill/Step Drill
解决缠屑问题, 孔入口无刮伤
For solving chip wind on cutter problem with no damage at the hole entrance



螺纹加工 Thread Machining

- 挤压/切削丝锥
Extortion/Cutting Tap
有效解决因丝锥磨损或断刀造成废品问题
Effectively solving discard cutter problem caused by abrasion or snap

侧孔精修 Side Hole Making

- 铝合金/塑胶立铣刀
Aluminum Alloy/Rubber Endmill
加工表面无毛刺, 刀具寿命高
Post processing surface has no bur with long tool life

深/窄槽加工 Deep/Narrow Slot Machining

- T型刀/燕尾刀
T-Shape Cutter/ Dovetail Cutter
解决深沟T槽易断刀问题
For solving the T-shape cutter easy to snap problem



外观面超精加工 Exterior Ultra-Fine Machining

- SA160外观立铣刀
SA160 Series Exterior Profile Endmill
加工表面无横纹、阴阳面等缺陷
Post processing surface has no defects such as horizontal grain or negative & positive faces etc.



防水面高精度加工 Waterproofed High Precision Face Machining

- 高精度球头涂层立铣刀
High Precision Ball Nose Coated Endmill
实现防水面高精度, 高寿命加工
Implementing waterproofed high precision surface with long tool life

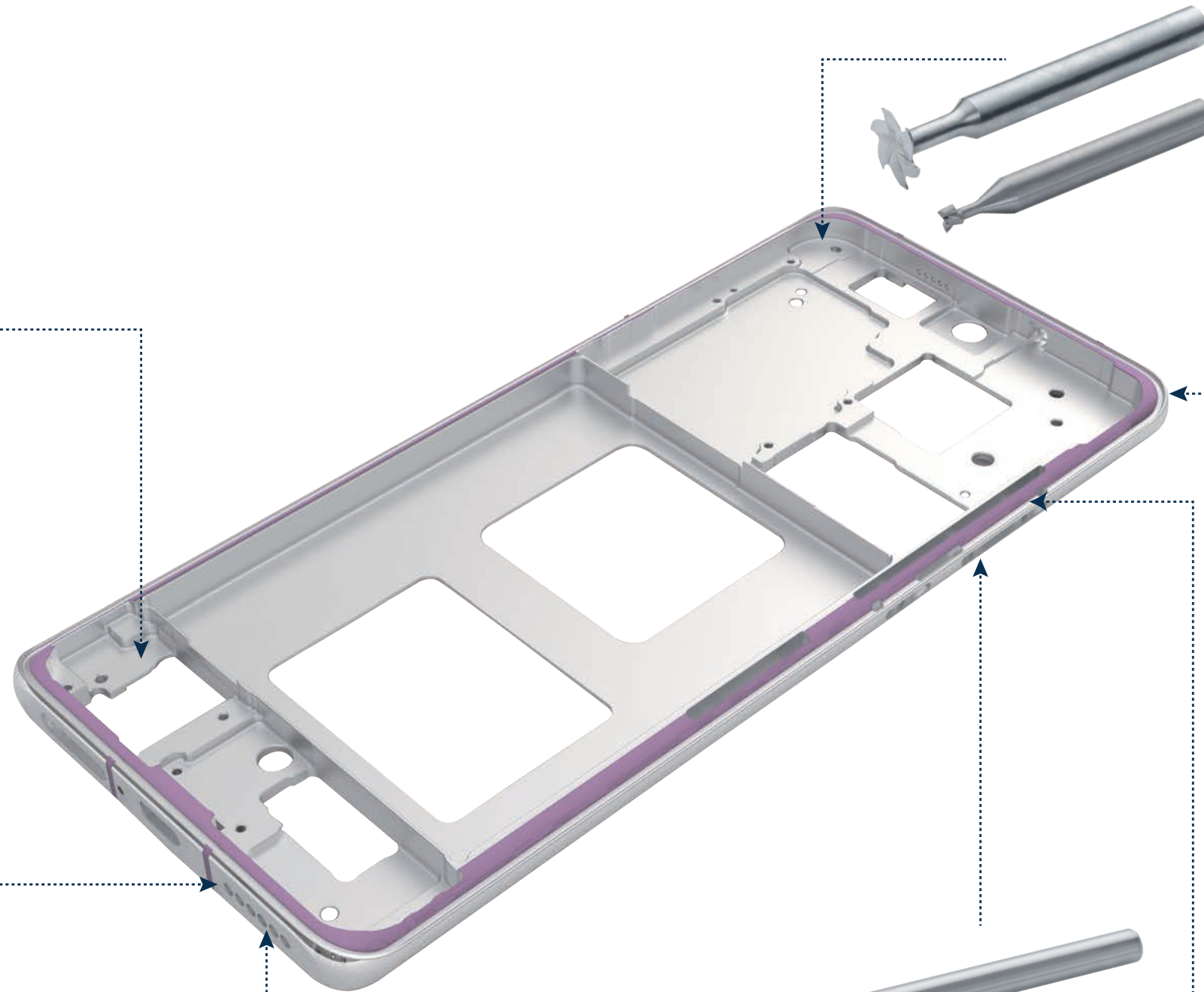

转轴外观加工 Shaft Exterior Machining

- 整硬成型外观立铣刀
Exterior Profile Solid Carbide Endmill
解决复合成型外观加工难题
For solving multi-profiling machining problem

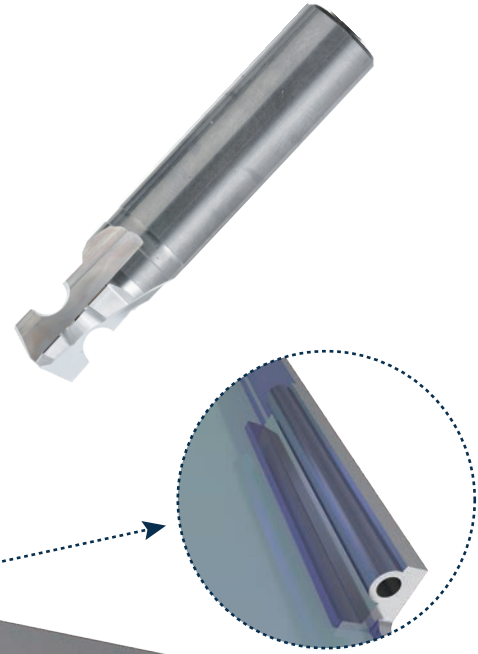

表面精车 Surface Fine Turning

- PCD圆刀片
PCD Round Insert
解决表面刀纹、应力变形
For solving cutting grain and stress deformation

型腔开粗/高效加工 Cavity Roughing/High Efficiency Machining

- SA210-NR粗加工系列刀具
SA210-NR Series Rough Machining Endmill
- SA100高效加工系列刀具
SA100 Series High Efficiency Machining
金属去除率高 ($Q \geq 300 \text{cm}^3/\text{min}$)、解决应力变形问题
High metal removal rate ($Q \geq 300 \text{cm}^3/\text{min}$), for solving stress deformation problem

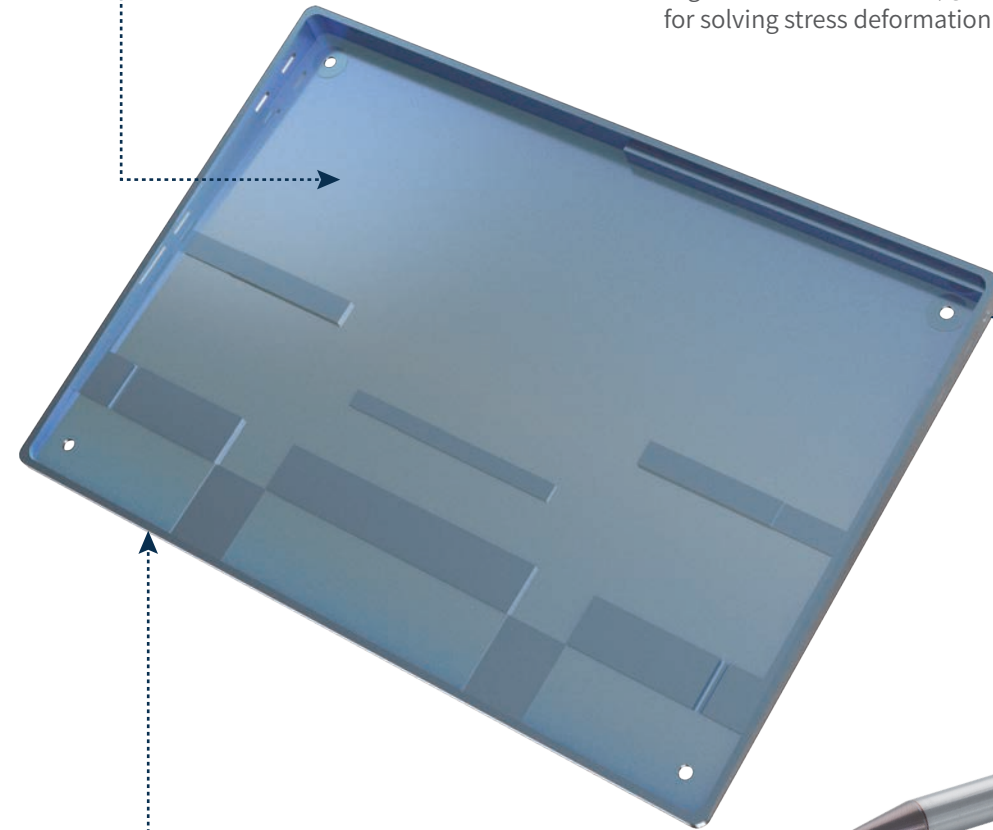

外观面超精加工 Exterior Ultra-Fine Machining

- SA160外观立铣刀
SA160 Series Exterior Profile Endmill
解决外观加工阴阳面问题 ($Ra < 0.1 \mu\text{m}$)
For solving negative & positive faces problem in exterior machining ($Ra < 0.1 \mu\text{m}$)

侧孔精修 Side Hole Making

- 铝合金立铣刀
Aluminum Alloy Endmill
加工表面无毛刺, 寿命高
Post processing surface has no bur with long tool life

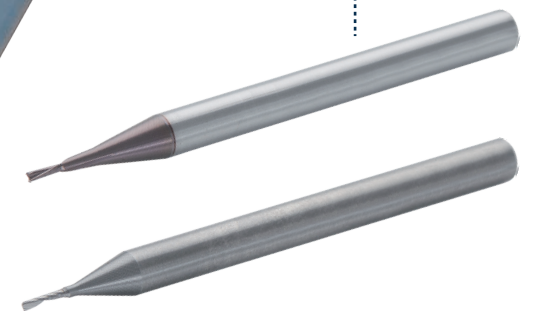

小零件车削加工 Small Part Turning

- 车刀片/切槽切断刀片
Turning Insert/Groove & Parting Insert
加工表面质量优异, 刀具寿命高
Great surface quality with long tool life

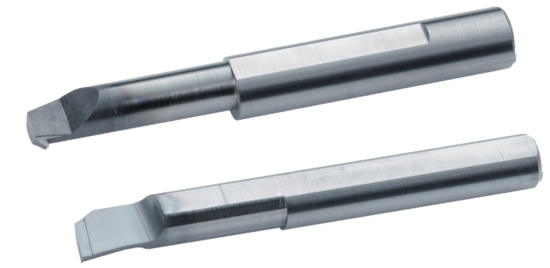

内孔镗削加工 Internal Boring Machine

- 小零件专用镗刀
Exclusive Boring Cutter for Small Parts
装夹方便, 定位准确, 刀具寿命高
Easy installation with accurate positioning and long tool life

成型轮廓高效加工 Profiling High Efficiency Machining

- 整硬底刃轮廓立铣刀
Solid Carbide Profiling Endmill
加工效率提升60%-150%
Increase processing efficiency by 60%-150%

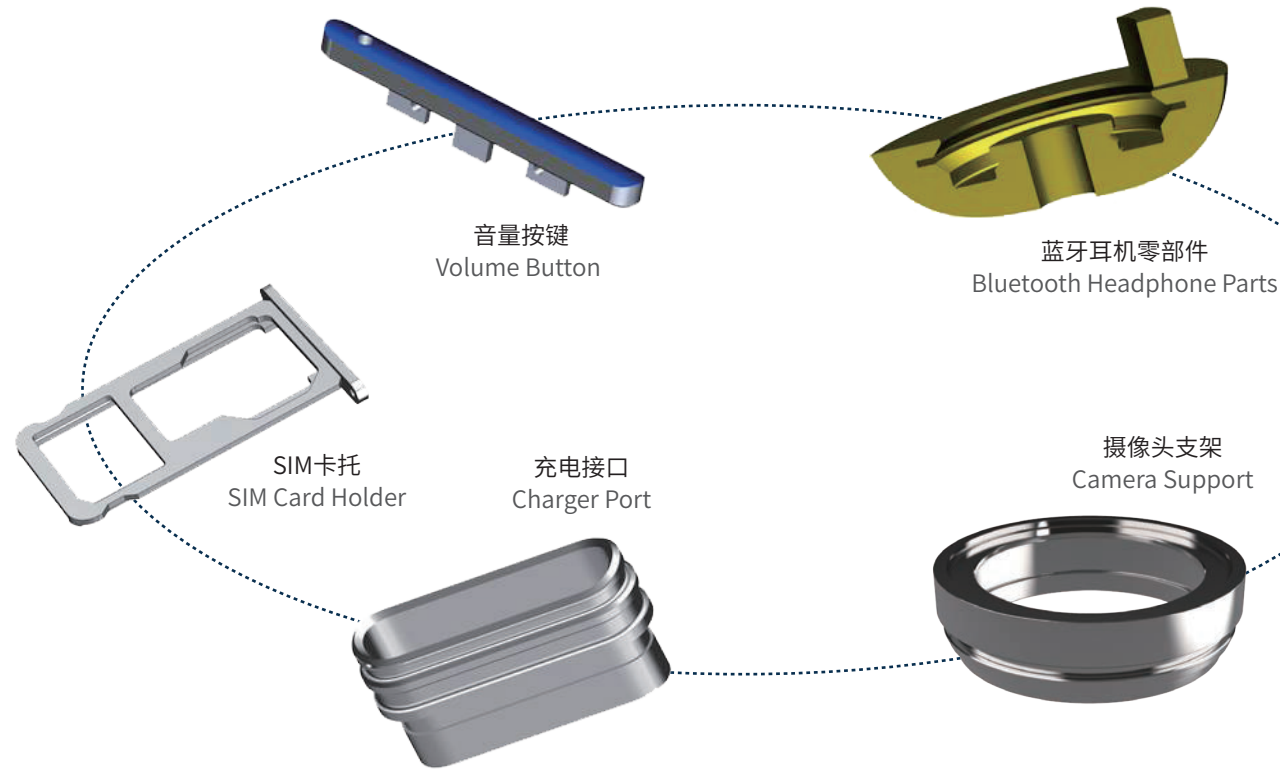

深/窄槽加工 Deep/Narrow Slot Machining

- T型刀
T-Shape Cutter
- 解决深沟T槽易断刀问题
For solving the T-shape cutter easy to snap problem

高效粗加工 High Efficiency Rough Machining

- SS600不锈钢高效立铣刀
SS600 Stainless Steel Endmill
加工效率可提升50%以上, 刀具寿命高
Processing efficiency increased by 50% with long tool life
- US260不锈钢通用/精修立铣刀
US260 General/Fine Machining Endmill for Stainless Steel



外观/高光加工 Exterior/Polishing Machining

- 不锈钢外观刀具/高光刀具
Exterior/Polishing Endmill for Stainless Steel
加工表面可达到外观效果/镜面效果
For achieving mirror effect on the machined surface



手机后盖轮廓粗加工 Rear Casing Contour Rough Machining for Mobile Phones

- 大规格成型轮廓金刚石砂轮
Large Dimension Contour Forming Diamond Grinding Wheel
一次加工成型, 显著提升加工效率
Improving machining efficiency effectively by single passing forming process



型腔粗加工 Cavity Rough Machining

- 电镀金刚石磨头
Galvanic Diamond Grinding Head
品质稳定, 加工寿命高
Stable quality with long tool life



陶瓷手表壳
Ceramic Watch Casing

陶瓷手表壳预烧后外形加工 Shape machining of ceramic watch shell after pre-firing

- PCD刀具
PCD Tool
品质稳定, 加工寿命高
Stable quality with long tool life



精加工 Fine Machining

- 电镀金刚石磨头
Galvanic Diamond Grinding Head
内腔3D面、底面精加工
Inner chamber, bottom surface fine machining



T槽加工 T Slot Machining

- 单层烧结金刚石磨头
Single Layer Annealed Diamond Grinding Head
解决深沟T槽加工
For solving T slot machining



孔加工 Hole Making

- 多层烧结金刚石磨头
Multi-layered Annealed Diamond Grinding Head
指纹孔、摄像孔加工
Fingerprint hole, camera hole processing

型腔、大面粗加工

Rough machining of cavity and large surface

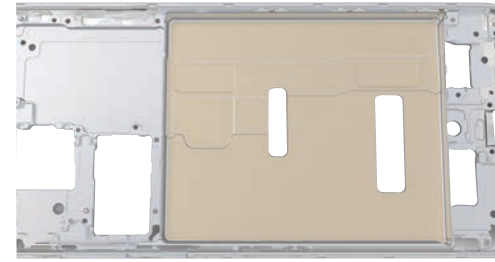

订货号 Ordering Code	名称 Product Name	规格 Specification	库存 Stock
PEARE02002C0CB	铜铝 2刃长颈圆角头立铣刀 D2*R0.2*3*6NL 2-Flute Long Neck Radius End Mill for Aluminum D2*R0.2*3*6NL	D2*R0.2*3*6*50*d4*D1.9	●
PEARE02002C2CX	铜铝 2刃长颈圆角头涂层立铣刀 D2*R0.2*3*6NL Coating 2-Flute Long Neck Radius End Mill for Aluminum D2*R0.2*3*6NL	D2*R0.2*3*6*50*d4*D1.9	●
PEARA03002C0CB	铜铝 2刃圆角头立铣刀 D3*R0.2*9 2-Flute Radius End Mill for Aluminum D3*R0.2*9	D3*R0.2*9*50*d4	●
PEARA03002C2CX	铜铝 2刃圆角头涂层立铣刀 D3*R0.2*9 Coating 2-Flute Radius End Mill for Aluminum D3*R0.2*9	D3*R0.2*9*50*d4	●
PEARF04002C0CB	铜铝 3刃圆角头立铣刀 D4*R0.2*9 3-Flute Radius End Mill for Aluminum D4*R0.2*9	D4*R0.2*9*50*d4	●
PEARG06002C0CB	铜铝 3刃短刃圆角头立铣刀 D6*R0.2*12 3-Short Flute Radius End Mill for Aluminum D6*R0.2*12	D6*R0.2*12*50*d6	●
PEARG08002C03B	铜铝 3刃短刃圆角头立铣刀 D8*R0.2*9 3-Short Flute Radius End Mill for Aluminum D8*R0.2*9	D8*R0.2*9*50*d8	●
PEARG08005C03B	铜铝 3刃短刃圆角头立铣刀 D8*R0.5*15 3-Short Flute Radius End Mill for Aluminum D8*R0.5*15	D8*R0.5*15*50*d8	●
PEARG10002C03B	铜铝 3刃短刃圆角头立铣刀 D10*R0.2*15 3-Short Flute Radius End Mill for Aluminum D10*R0.2*15	D10*R0.2*15*50*d10	●
PEARG12005C03B	铜铝 3刃短刃圆角头立铣刀 D12*R0.5*15 3-Short Flute Radius End Mill for Aluminum D12*R0.5*15	D12*R0.5*15*50*d12	●
PEASF02006C0CB	铜铝 3刃平头立铣刀 D2*6 3-Flute Square End Mill for Aluminum D2*6	D2*6*50*d4	●
PEASF03009C9CB	铜铝 3刃平头立铣刀 D3*9 3-Flute Square End Mill for Aluminum D3*9	D3*9*50*d4	●
PEASG04009C0CB	铜铝 3刃短刃平头立铣刀 D4*9 3-Short Flute Square End Mill for Aluminum D4*9	D4*9*50*d4	●
PEASG06012C03B	铜铝 3刃短刃平头立铣刀 D6*12 3-Short Flute Square End Mill for Aluminum D6*12	D6*12*50*d6	●
PEASG08015C03B	铜铝 3刃短刃平头立铣刀 D8*15 3-Short Flute Square End Mill for Aluminum D8*15	D8*15*50*d8	●

侧孔粗加工

Rough machining of side hole



订货号 Ordering Code	名称 Product Name	规格 Specification	库存 Stock
PEARA01002C0CB	铜铝 2刃圆角头立铣刀 D1*R0.2*3 2-Flute Radius End Mill for Aluminum D1*R0.2*3	D1*R0.2*3*50*d4	●
PEARA01002C2CX	铜铝 2刃圆角头涂层立铣刀 D1*R0.2*3 Coating 2-Flute Radius End Mill for Aluminum D1*R0.2*3	D1*R0.2*3*50*d4	●
PEARE01002C2CX	铜铝 2刃长颈圆角头涂层立铣刀 D1*R0.2*2*5NL Coating 2-Flute Long Neck Radius End Mill for Aluminum D1*R0.2*2*5NL	D1*R0.2*2*5*50*d4*D0.9	●
PEARE01202C2CX	铜铝 2刃长颈圆角头涂层立铣刀 D1.2*R0.2*3*5NL Coating 2-Flute Long Neck Radius End Mill for Aluminum D1.2*R0.2*3*5NL	D1.2*R0.2*3*5*50*d4*D1.1	●
PEARE01502C2CX	铜铝 2刃长颈圆角头涂层立铣刀 D1.5*R0.2*3*6NL Coating 2-Flute Long Neck Radius End Mill for Aluminum D1.5*R0.2*3*6NL	D1.5*R0.2*3*6*50*d4*D1.4	●

内腔、导电位精加工

Finish machining of inner cavity and conductive position



订货号 Ordering Code	名称 Product Name	规格 Specification	库存 Stock
PEASA02006C0CB	铜铝 2刃平头立铣刀 D2*6 2-Flute Square End Mill for Aluminum D2*6	D2*6*50*d4	●
PEASA02006C1CX	铜铝 2刃平头涂层立铣刀 D2*6 Coating 2-Flute Square End Mill for Aluminum D2*6	D2*6*50*d4	●
PEASF03009C0CB	铜铝 3刃平头立铣刀 D3*9 3-Flute Square End Mill for Aluminum D3*9	D3*9*50*d4	●
PEASA03009C1CX	铜铝 2刃平头涂层立铣刀 D3*9 Coating 2-Flute Square End Mill for Aluminum D3*9	D3*9*50*d4	●
PEAS102006010BDNN125P	PCD 1刃平头立铣刀 D2*6 PCD 1-Flute Square End Mill D2*6	D2*6*50*d4	●
PEAS103006010BDNN125P	PCD 1刃平头立铣刀 D3*6 PCD 1-Flute Square End Mill D3*6	D3*6*50*d4	●
PEASB04006010BDNN125P	PCD 2刃平头立铣刀 D4*6 PCD 2-Flute Square End Mill D4*6	D4*6*50*d4	●
PEASB06006010BDNN125P	PCD 2刃平头立铣刀 D6*6 PCD 2-Flute Square End Mill D6*6	D6*6*50*d6	●

侧孔精加工
Finish machining of side hole



订货号 Ordering Code	名称 Product Name	规格 Specification	库存 Stock
PEASA00501C1CX	铜铝 2刃平头涂层立铣刀 D0.5*1 Coating 2-Flute Square End Mill for Aluminum D0.5*1	D0.5*1*50*d4	●
PEASC00502C1CX	铜铝 2刃长刃平头涂层立铣刀 D0.5*2 Coating 2-Long Flute Square End Mill for Aluminum D0.5*2	D0.5*2*50*d4	●
PEASC00603C1CX	铜铝 2刃长刃平头涂层立铣刀 D0.6*2.5 Coating 2-Long Flute Square End Mill for Aluminum D0.6*2.5	D0.6*2.5*50*d4	●
PEASC00703C1CX	铜铝 2刃长刃平头涂层立铣刀 D0.7*3 Coating 2-Long Flute Square End Mill for Aluminum D0.7*3	D0.7*3*50*d4	●
PEASC00803C12X	铜铝 2刃长刃平头涂层立铣刀 D0.8*3 Coating 2-Long Flute Square End Mill for Aluminum D0.8*3	D0.8*3*50*d4	●
PEASA01003C0CB	铜铝 2刃平头立铣刀 D1*3 2-Flute Square End Mill for Aluminum D1*3	D1*3*50*d4	●
PEASA01003C1CX	铜铝 2刃平头涂层立铣刀 D1*3 Coating 2-Flute Square End Mill for Aluminum D1*3	D1*3*50*d4	●
PEASC01005C0CB	铜铝 2刃长刃平头立铣刀 D1*5 2-Long Flute Square End Mill for Aluminum D1*5	D1*5*50*d4	●
PEASC01005C1CX	铜铝 2刃长刃平头涂层立铣刀 D1*5 Coating 2-Long Flute Square End Mill for Aluminum D1*5	D1*5*50*d4	●
PEASB01503C1CX	铜铝 2刃短刃平头涂层立铣刀 D1.5*3 2-Short Flute Square End Mill for Aluminum D1.5*3	D1.5*3*50*d4	●
PEASF01504C0CB	铜铝 3刃平头立铣刀 D1.5*4 3-Flute Square End Mill for Aluminum D1.5*4	D1.5*4*50*d4	●
PEASF01504C1CX	铜铝 3刃平头涂层立铣刀 D1.5*4 Coating 3-Flute Square End Mill for Aluminum D1.5*4	D1.5*4*50*d4	●
PEASC01506C0CB	铜铝 2刃长刃平头立铣刀 D1.5*6 2-Long Flute Square End Mill for Aluminum D1.5*6	D1.5*6*50*d4	●
PEASC01506C1CX	铜铝 2刃长刃涂层平头立铣刀 D1.5*6 Coating 2-Long Flute Square End Mill for Aluminum D1.5*6	D1.5*6*50*d4	●
PEASA00601C1CX	铜铝 2刃长颈平头涂层立铣刀 D0.6*1*2NL Coating 2-Flute Long Neck Square End Mill for Aluminum D0.6*1*2NL	D0.6*1*2*50*d4*D0.55	●
PEASE01006C1CX	铜铝 2刃长颈平头涂层立铣刀 D1*2*6NL Coating 2-Flute Long Neck Square End Mill for Aluminum D1*2*6NL	D1*2*6*50*d4*D0.9	●
PEASE01007C1CX	铜铝 2刃长颈平头涂层立铣刀 D1*3*7NL Coating 2-Flute Long Neck Square End Mill for Aluminum D1*3*7NL	D1*3*7*50*d4*D0.9	●
PEASE01405C1CX	铜铝 2刃长颈平头涂层立铣刀 D1.4*3*5NL Coating 2-Flute Long Neck Square End Mill for Aluminum D1.4*3*5NL	D1.4*3*5*50*d4*D1.3	●
PEASE01506C1CX	铜铝 2刃长颈平头涂层立铣刀 D1.5*3*6NL Coating 2-Flute Long Neck Square End Mill for Aluminum D1.5*3*6NL	D1.5*3*6*50*d4*D1.4	●
PEASE01809C1CX	铜铝 2刃长颈平头涂层立铣刀 D1.8*3*9NL Coating 2-Flute Long Neck Square End Mill for Aluminum D1.8*3*9NL	D1.8*3*9*50*d4*D1.7	●

3D面精加工
Finish machining of curved surface

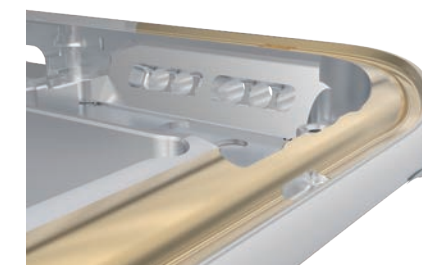

订货号 Ordering Code	名称 Product Name	规格 Specification	库存 Stock
PEABE00602C1CX	铜铝 2刃长颈球头涂层立铣刀 R0.3*1*2NL Coating 2-Flute Long Neck Ball End Mill for Aluminum R0.3*1*2NL	R0.3*1*2*50*d4*D0.55	●
PEABA00802C1CX	铜铝 2刃球头涂层立铣刀 R0.4*2 Coating 2-Flute Ball End Mill for Aluminum R0.4*2	R0.4*2*50*d4	●
PEABA01002C1CX	铜铝 2刃球头涂层立铣刀 R0.5*2 Coating 2-Flute Ball End Mill for Aluminum R0.5*2	R0.5*2*50*d4	●
PEABC02006C1CX	铜铝 2刃球头涂层立铣刀 R0.5*2 Coating 2-Flute Ball End Mill for Aluminum R0.5*2	R1*6*50*d4	●
PEARA00602C1CX	铜铝 2刃圆角头涂层立铣刀 D0.6*R0.2*1.5 Coating 2-Flute Radius End Mill for Aluminum D0.6*R0.2*1.5	D0.6*R0.2*1.5*50*d4	●
PEARA00702C1CX	铜铝 2刃圆角头涂层立铣刀 D0.7*R0.2*1 Coating 2-Flute Radius End Mill for Aluminum D0.7*R0.2*1	D0.7*R0.2*1*50*d4	●
PEARB00802C1CX	铜铝 2刃短刃圆角头涂层立铣刀 D0.8*R0.2*1 Coating 2-Short Flute Radius End Mill for Aluminum D0.8*R0.2*1	D0.8*R0.2*1*50*d4	●

螺纹底孔、音量孔加工
Machining of Threaded Bottom Hole and Volume Hole



订货号 Ordering Code	名称 Product Name	规格 Specification	库存 Stock
PDACD301305C03B	铜铝 3D麻花钻 D1.265*5 3D Twist Drill for Aluminum D1.265*5	D1.265*5*50*d4	●
PDACD301106C03B	铜铝 3D麻花钻 D1.1*6 3D Twist Drill for Aluminum D1.1*6	D1.1*6*50*d4	●
PDACD501008C03B	铜铝 5D麻花钻 D1*8 5D Twist Drill for Aluminum D1*8	D1*8*50*d4	●

