

MICRO-TOOLS FOR BORING

INCLUDING BORING, GROOVING AND THREADING.



- Three major series cover the machining of stainless steel, carbon steel, and high-hardness steel.
- By pairing with different materials and coatings, they meet the processing requirements for high wear resistance and high surface finish.
- Processing range D1-D8 with complete specifications and sufficient stock.



Tap

- Complete range: encompassing both high-performance and cost-effective options, available in both metric and American system.
- cover mainly P/M/N/K materials processing.

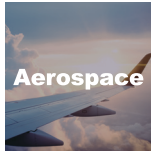

Aerospace

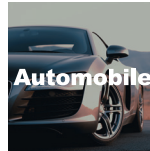

Automobile

APPLICATION INDUSTRY



Energy and Heavy Machinery



Medical



General Machinery



Mould



3C

CONTACT US

Asia Pacific Region

Contact: **Wing Liu**
Tel : +86 0592 7255172

South Asia-Middle East Region

Contact: **Ryan Lu**
Tel : +86 0592 7255079

Russian Region

Contact: **Irina Yi**
Tel : +86 0592 7255079

European Region

Contact: **Gene Ji**
Tel :+86 0592 7230139

America Region

Contact: **Abraham Chen**
Tel : +86 0592 7230132

E-mail: gesac.tool@ctxc.com

Web: www.gesac.net



GESAC

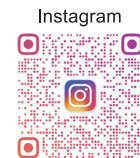

gesac_cutting_tool



Gesac tool



GESAC



GESAC



厦门金鹭特种合金有限公司
XIAMEN GOLDEN ECLET SPECIAL ALLOY CO., LTD.

GLOBAL DISTRIBUTION



SUBSIDIARY CORPORATION

China | Germany | Japan | Thailand | Brazil

Marketing and service networks have spread all over more than 40 countries and regions such as Europe, South America and Asia. We provide our customers with high-quality products and services quickly.



“

WHO IS GESAC

Xiamen Golden Egret Special Alloy Co., Ltd. (GESAC), founded in 1989, is a Sino-foreign joint venture with national high-tech, affiliated with XTC, which is one of six major rare earth groups in China. GESAC is committed to research & development, production and professional solutions providing of high-quality tungsten powder materials, cemented carbide, precision cutting tools and other tungsten products. Up to now, GESAC has become world-famous manufacturer and supplier of tungsten powder, cemented carbide and precision cutting tools products.

WE HAVE THE MOST COMPLETE TUNGSTEN INDUSTRY CHAIN

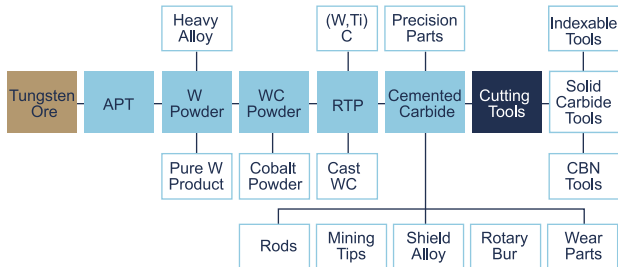

SWISS-TYPE CENTERING MACHINE TOOLS

FOR SMALL PRECISION PARTS AND MEDICAL INDUSTRY

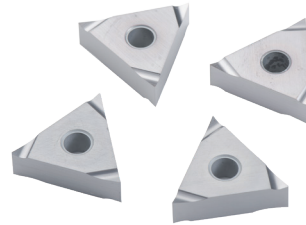

- Sharp cutting edge design with new GAT71 series grades to improve the surface finish of workpiece;
- A wide range of product specifications, realizing a total turning solution for excircle, inner hole, back turning, grooving and threading.

LNMX+MKF115

NEGATIVE FOUR BLAZES HIGH FEED INDEXABLE MILLING TOOL

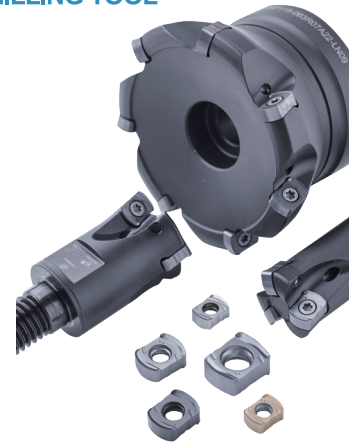

- Light, heavy and medium-type chip-breakers are available in a wide range of specifications and grades to meet a variety of processing needs.
- Achieve lighter, faster and more efficient cutting in roughing in molds, aerospace and other fields.

ST300

TITANIUM HIGH-PERFORMANCE END MILLS

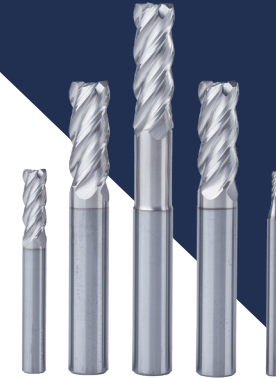

- New titanium alloy milling grade GSR7115 is adopted, which provides significant improvement in wear and bonding resistance.

UP210

PLAIN STEEL GENERAL PROCESSING END MILL



- With nearly 20 models, more than three hundred specifications, complete stock, to meet the needs of a variety of working conditions

CBN/PCD TOOL

PCBN inserts coated grade BHC100P/BHC200P

PCD turning insert with chip-breaker DNF/DNM



GESAC